

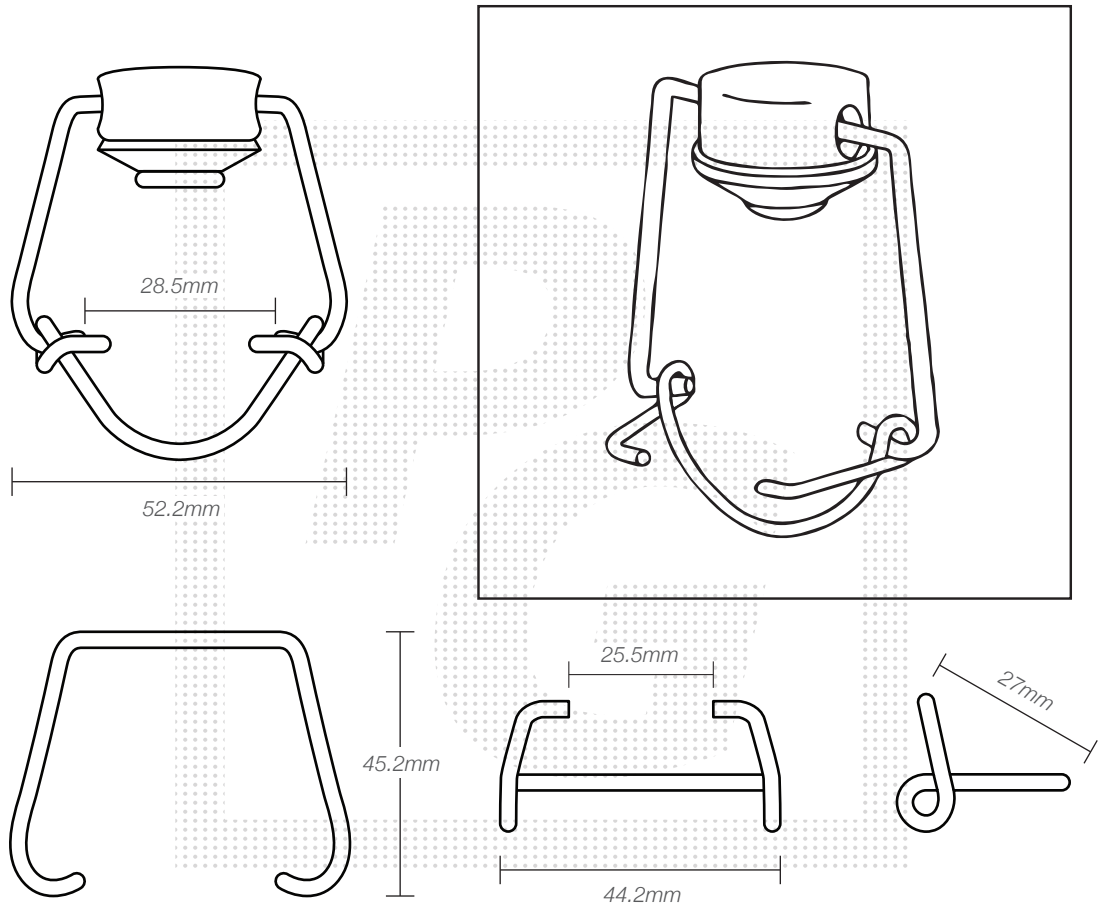





Swing Stopper



 weight	 size	 height	 Diameter	 neck finish	 colour
N/a	Standard	45.2mm	52.2mm	Swing	White with red rubber

Pattersons Glass Ltd

Telephone: +44 (0) 1472 340005
Email: sales@jarsandbottles.co.uk

Facebook: @Pattersons Group
Twitter: @Pattersons Group
Web: www.jarsandbottles.co.uk