

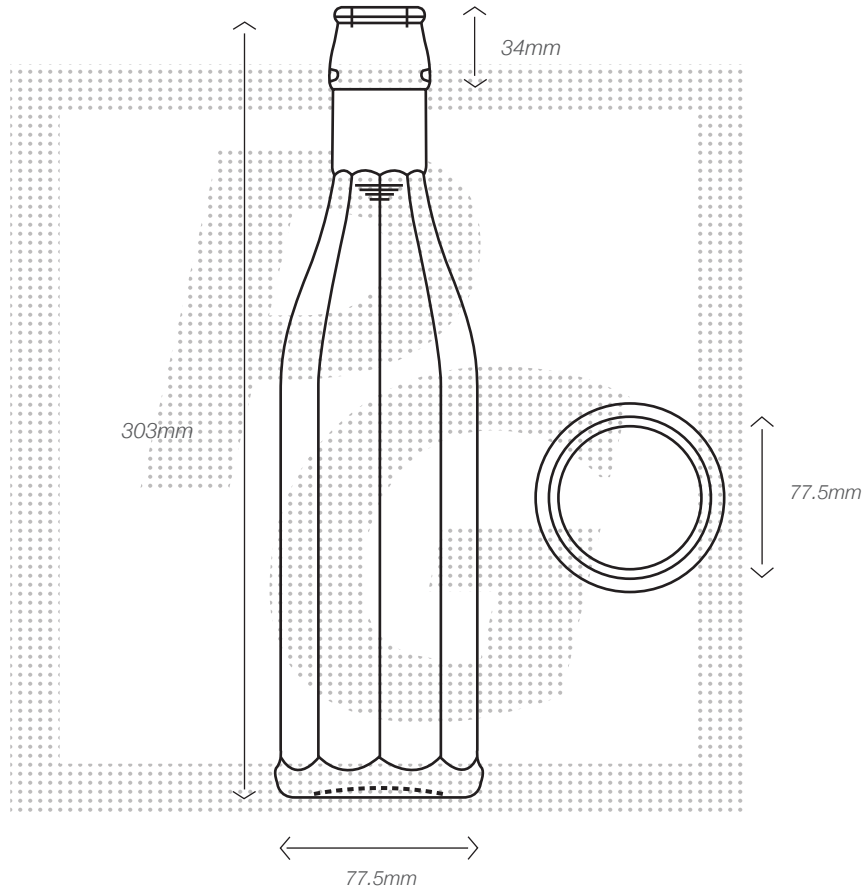







## Costalata Bottles

750ml



Product Code - BRU015

 weight	 ml	 height	 Diameter	 colour	 neck finish	 label size
480g	750ml	303mm	77.5mm	FLINT	swing stopper	n/a

### Pattersons Glass Ltd

Telephone: +44 (0) 1472 340005

Fax: +44 (0) 1472 241573

Email: [sales@jarsandbottles.co.uk](mailto:sales@jarsandbottles.co.uk)

Facebook: @Pattersons Group

Twitter: @Pattersons Group

Web: [www.jarsandbottles.co.uk](http://www.jarsandbottles.co.uk)